

# 2408i Indicator and Alarm Unit



## 1 User Guide

Thank you for choosing the 2408i panel mounted indicator. It will provide accurate measurement and display of temperature and other process variables. A modular build accepts a wide range of plug-in modules allowing: up to four alarm outputs, two process variable (PV) inputs, direct strain gauge/pressure sensor measurements, custom linearisation, analogue retransmission, remote setpoint (SP) input and digital communications.

The indicator is supplied configured in accordance with the order code. The order code and instrument serial number is shown on a label fixed to the top of the case, and this can be checked against the order code given in section 3 of these instructions.

### 1.1 CONTENTS OF PACKAGE

1. A peel-off label set - a convenient position is to fix a label to the top right of the display.
2. A 2.49Ω resistor used as the load resistor for mA inputs
3. Two panel retaining clips

| °C       | °F   | K                  | kPa     | V       | mV     |
|----------|------|--------------------|---------|---------|--------|
| m/s      | cm/s | l/h                | mWG     | A       | mA     |
| x10      | 1x10 | l/min              | T/h     | %       | %RH    |
| p.s.i    | bar  | mbar               | mPas    | %pH     | pH     |
| p.s.i.x1 | mmHg | Kg/cm <sup>2</sup> | gal/min | rev/min | mile/h |
| 0        |      |                    |         |         | Amps   |

### 1.2 DIMENSIONS AND INSTALLATION

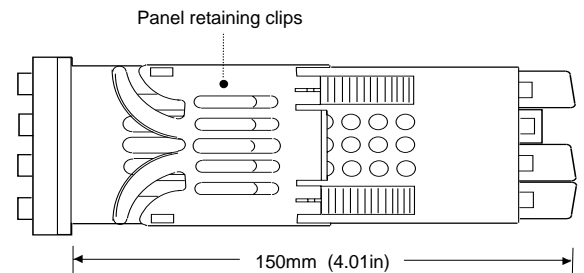
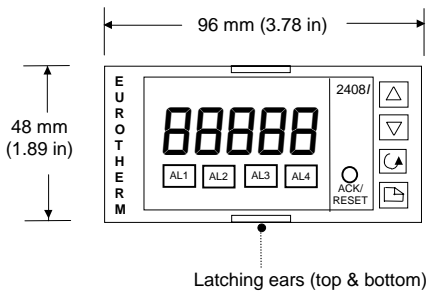

#### 1.2.1 To Install the Indicator

Please read the safety information in section 4 before proceeding. The indicator is intended to be mounted on a panel within an enclosure such as a control cubicle.

1. Prepare the panel cut-out to the size shown.
2. Insert the indicator through the cut-out.
3. Spring the panel retaining clips into place. Secure the indicator in position by holding it level and pushing both retaining clips forward.
4. Peel off the plastic film protecting the front of the indicator.

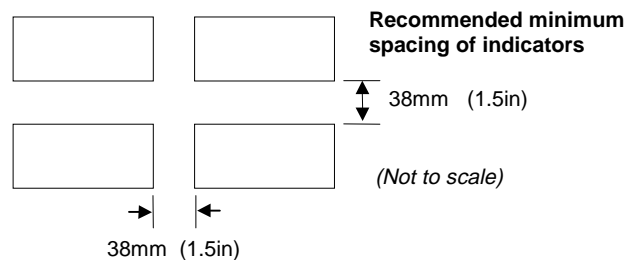
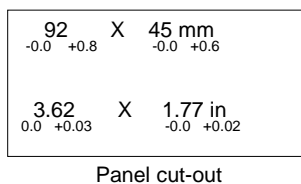

#### 1.2.2 Removing The Indicator From The Sleeve



The indicator can be removed from its sleeve by easing the latching ears outwards and pulling it forward out of the sleeve. When plugging the indicator back into its sleeve, ensure that the latching ears click into place to maintain the moisture sealing protection.

CE This indicator meets the European directives on safety and EMC



## 1.3 ELECTRICAL CONNECTIONS

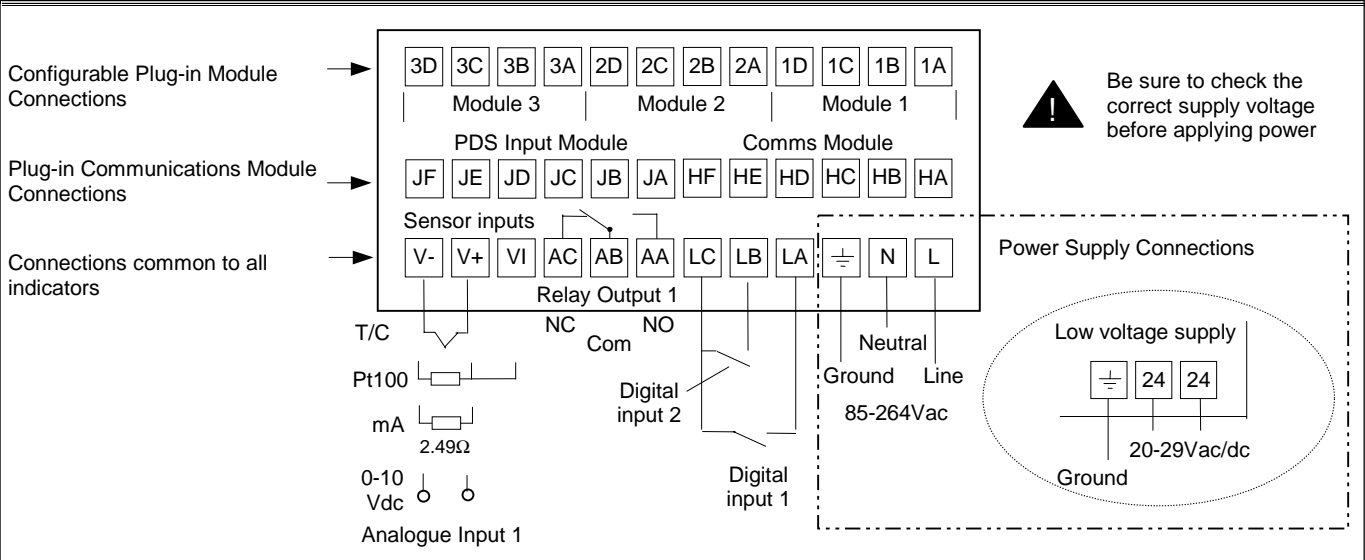

### 1.3.1 Wiring

The screw terminals accept wire sizes from 0.5 to 1.5 mm (16 to 22 AWG) and should be tightened to a torque of 0.4Nm (3.5lb in). Hinged terminal covers provide IP20 protection.

### 1.3.2 Plug-in Module Connections

Modules are fitted in positions 1, 2 and 3 in accordance with the ordering code. The tables below show the connections for each module and the possible functions they can perform.

Note: On the wiring label the module number precedes the terminal identity letter given in the table below. For example, 1A, 1B, 1C.

| Module Type                                 | Terminal Identity |   |   |   | Typical Functions                              |
|---|-------------------|---|---|---|--|
|   | A                 | B | C | D |  |
| Relay; changeover                           |                   |   |   |   | Alarm or Event                                 |
| Dual relay (normally open)                  |                   |   |   |   | Alarms or events                               |
| DC retransmission                           | +                 | - |   |   | Retrans. of PV                                 |
| Transmitter supply 24V                      | +                 | - |   |   | To power transmitters                          |
| Strain Gauge Transducer supply (see note 1) | +                 | - |   |   | To power strain gauges. (5V or 10V selectable) |

| Module Type   | Terminal Identity |     |     |     | Typical Functions         |
|---|-------------------|-----|-----|-----|---------------------------|
|   | A                 | B   | C   | D   |                           |
| 2nd Analogue Input (Analogue Input 2) (module 3 only) |                   |     | +   | -   | Thermocouple              |
|   |                   |     | +   | -   | PRT                       |
|   |                   |     | +   | -   | mA (2.49Ω sense resistor) |
|   |                   |     | +   | -   | High impedance 0 - 2.0Vdc |
|   |                   |     | +   | -   | millivolts                |
|   | +                 |     |     | -   | 0 - 10Vdc                 |
| Triple contact input                                  | ip1               | ip2 | ip3 | Com |                           |
| Triple digital input                                  | ip1               | ip2 | ip3 | Com |                           |
| Triple digital output                                 | op1               | op2 | op3 |     |                           |

Notes:-

- By default:
  - The transducer supply for input 1 is installed in module position 2
  - The transducer supply for input 2 is installed in module position 1
- All module connections are isolated from the process value, earth, incoming supply and connections to other modules.
- Digital inputs are non-isolated from the process value. Digital inputs are powered by the indicator. Switching voltage and current 24Vdc/20mA.



See Section 5 for specifications and maximum safety limits

### 1.3.3 Communications Modules

| Digital Communications Module |                   |     |     |       |       |
|-------------------------------|-------------------|-----|-----|-------|-------|
| Module type                   | Terminal identity |     |     |       |       |
|                               | HB                | HC  | HD  | HE    | HF    |
| RS232                         | -                 | -   | Com | Rx    | Tx    |
| RS485 (2-wire)                | -                 | -   | Com | A (+) | B (-) |
| RS485 (4-wire)                | Rx+               | Rx- | Com | Tx+   | Tx-   |
| Profibus                      | Shield            | VP  | B   | A     | DGND  |

| PDS Module     |                   |        |        |
|----------------|-------------------|--------|--------|
| Setpoint Input | Terminal identity |        |        |
|                | JD                | JE     | JF     |
|                | -                 | Signal | Common |

## 2 Operation

Switch on the indicator. After a 3 second self-test sequence, you will see the display shown below. This is called the 'HOME' display.

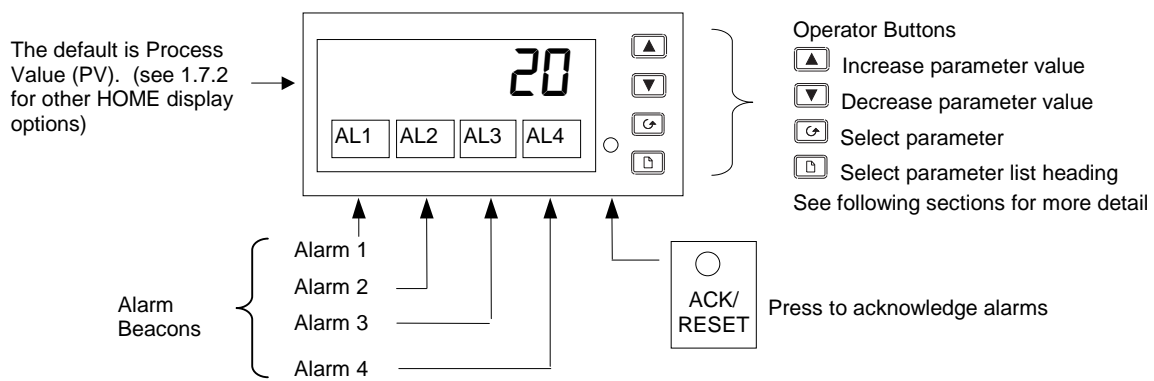

### 2.1.1 To View The Display Units

If the indicator has been configured for a thermocouple or RTD input, the temperature units can be viewed as follows:

| Do This                                       | This Is The Display You Should See | Additional Notes   |
|---|------------------------------------|--|
| 1. Press and quickly release the  or  button. |                                    | <p><b>Display Units</b></p> <p>°C Celsius OR °F Fahrenheit OR °K Kelvin</p> <p>The display units are shown for 0.5 second</p> <p>Note: For linear inputs no units are displayed and, in this case:</p> <p>Pressing  goes directly to the <i>SP</i> display - see 1.7.2..</p> <p>Pressing  goes directly to the <i>AL</i> List - see 1.7.3.</p> |

### 2.1.2 Home Display Options

When shipped from the factory the HOME display will show the measured temperature or process value. This is the 'front' display. If either or is pressed the display changes to the 'back' display for a period of two seconds. The back display can show an alternative measurement, such as alarm setpoint or second PV input value.

| Do This  | This Is The Display You Should See | Additional Notes   |
|--|------------------------------------|--|
| <p><b>Example</b></p> 1. From the HOME display, press  or <p>2. Press  or  again to adjust the Alarm Setpoint between hi &amp; lo limits</p> |                                    | <p>Parameters which can be allocated to the Front and Back displays</p> <p>&lt;nonE&gt; The HOME display will be blank and only alarm messages will be flashed</p> <p>&lt;SP&gt; Setpoint (for deviation alarms)</p> <p>&lt;rm.SP&gt; Remote setpoint (for deviation alarms)</p> <p>&lt;PU.Hi&gt; Displays the maximum value on input 1</p> <p>&lt;PU.Lo&gt; Displays the minimum value on input 1</p> <p>&lt;PV&gt; Process Value</p> <p>&lt;AL.SP&gt; Alarm 1 setpoint</p> <p>&lt;L1&gt; Linearised input 1</p> <p>&lt;L2&gt; Linearised input 2</p> <p>Note:</p> <p>If the indicator has been ordered to read the highest (order code HI) or lowest values (order code LO) between input 1 and 2, the display shows only this value.</p> <p>If PV function ordered as FN, the displayed reading will be derived from inputs 1 and 2.</p> <p>The back display is not selectable in this mode</p> |



Pressing and together will always return you to the HOME display.

OR

The display will always return to the HOME display if no button is pressed within 45 seconds.

This time is reduced to 10 seconds if an alarm is being displayed.

## 2.2 ALARMS

**Alarms** are used to alert an operator when a pre-set level has been exceeded. They are normally used to switch an output (see 1.10) – usually a relay – to provide external actions to the process.

**Soft Alarms** are indication only and do not operate an output.

**Events** are generally defined as conditions, which occur as part of the operation of the plant. They do not require operator intervention and, therefore, do not cause an alarm message to be displayed. They can be attached to operate an output (relay) in the same way as an alarm.

### 2.2.1 Types of Alarm Used In The 2408i

This section shows graphically the operation of different types of alarm used in the indicator. The graphs show changes in PV plotted against time. The PV may be derived from input 1, input 2 or the main PV, which is derived from input 1 & 2.

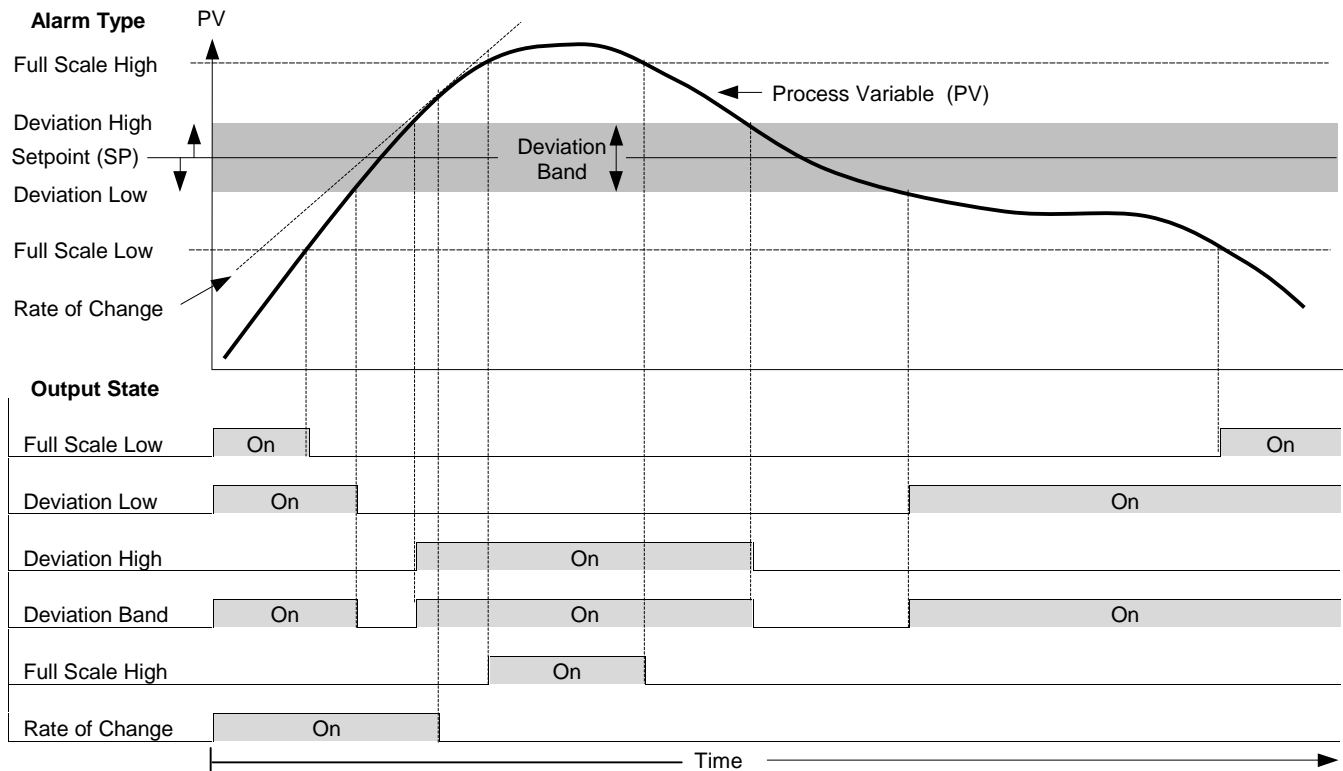

**Rate of change alarms** detect if the rate of change in PV, set as units per minute or per second, exceeds the setpoint value. An alarm setpoint set + will detect positive rates of change. An alarm setpoint set - will detect negative rates of change. Therefore, if it is required to measure the rate of change in both directions then two alarms must be configured. Since rate of change alarms are calculated over a period of time a small delay may be apparent before the alarm is indicated. This is generally only noticeable if the PV changes very quickly.

**Hysteresis** is the difference between the point at which the alarm switches ON and the point at which it switches OFF. It is used to prevent relay chatter.

**Latching Alarms** see section 2.2.6.

**Deviation Alarms.** The setpoint used for deviation alarms is normally derived as a remote input from another device - for example, a temperature controller. The setpoint can also be internally set within the controller - in this case called the local setpoint value.

**Delay** a settable time between an alarm occurring and it being displayed on the indicator

**Blocking Alarms** only occur after the start up phase when the alarm has first entered a safe state. The alarm is only indicated the next time it is active. It is used, for example, to ignore start up conditions which are not representative of running conditions.

### 2.2.2 Alarm Relay Output

Alarms can operate a specific logic or relay output. Any individual alarm can operate an individual relay or any combination of alarms can operate an individual relay. They are either supplied pre-configured in accordance with the ordering code or set up in configuration level.

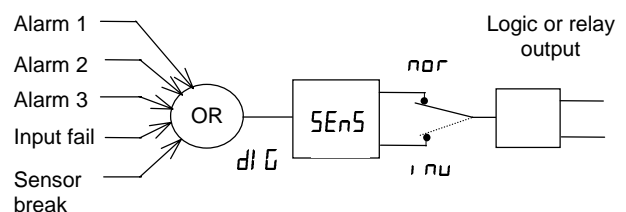

Any combination of alarms can operate the logic or relay output. Typical alarms are shown

## 2.2.3 Alarm Indication

An alarm occurs when the process conditions exceed a pre-set level (setpoint). It will be displayed on the indicator as follows:-

1. The relevant alarm beacon will begin to flash
2. A four character alarm message will be shown as a double flash in the main display. This message specifies the alarm number (first character) and the type of alarm that has occurred (next three characters). The message is flashed in addition to the 'front' displayed value

If more than one alarm is present the relevant beacon illuminates and further messages are flashed in the main display. The alarm indication will continue while the alarm condition is present and is not acknowledged.

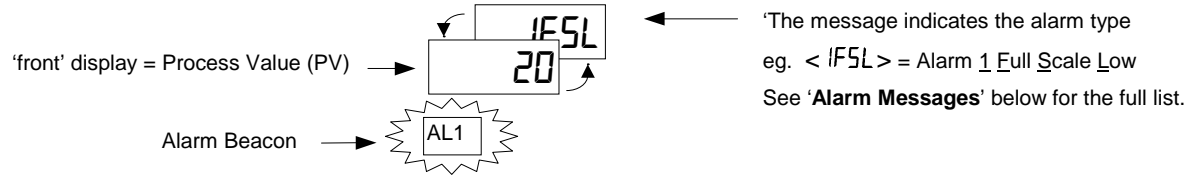

## 2.2.4 Alarm Messages

| Display                      | Alarm type               | Input Source | Alarm description and function |  |   |
|------------------------------|--------------------------|--------------|--------------------------------|--|---|
| <b>First character</b>       |                          |              |                                |  |   |
| 1---                         |                          |              | Alarm <u>1</u> is active       |  |   |
| 2---                         |                          |              | Alarm <u>2</u> is active       |  |   |
| 3---                         |                          |              | Alarm <u>3</u> is active       |  |   |
| 4---                         |                          |              | Alarm <u>4</u> is active       |  |   |
| <b>Last three characters</b> |                          |              |                                |  |   |
| -F5L                         | Full Scale Low           | Main PV      | The process value is:-         | below the low alarm setting  |   |
| -FL1                         |                          | PV 1         |                                | below the low alarm setting on PV 1  |   |
| -FL2                         |                          | PV 2         |                                | below the low alarm setting on PV 2  |   |
| -F5H                         | Full Scale High          | Main PV      |                                | above the high alarm setting   |   |
| -FH1                         |                          | PV 1         |                                | above the high alarm setting on PV 1   |   |
| -FH2                         |                          | PV 2         |                                | above the high alarm setting on PV 2   |   |
| -dLo                         | Deviation Low            | Main PV      |                                | below the high and low deviation setting on main PV                              |   |
| -dL1                         |                          | PV 1         |                                | below the high and low deviation setting on PV1                                  |   |
| -dL2                         |                          | PV 2         |                                | below the high and low deviation setting on PV2                                  |   |
| -dHi                         | Deviation High           | Main PV      |                                | above the high and low deviation setting on main PV                              |   |
| -dH1                         |                          | PV 1         |                                | above the high and low deviation setting on PV1                                  |   |
| -dH2                         |                          | PV 2         |                                | above the high and low deviation setting on PV2                                  |   |
| -dEu                         | Deviation Band           | Main PV      |                                | above or below the high and low deviation setting on main PV                     |   |
| -du1                         |                          | PV 1         |                                | above or below the high and low deviation setting on PV1                         |   |
| -du2                         |                          | PV 2         |                                | above or below the high and low deviation setting on PV2                         |   |
| -rAt                         | Rate of change (minutes) | Main PV      |                                | changing faster than the rate-of change alarm setting in minutes for main input. |   |
| -rAs                         | Rate of change (seconds) | Main PV      |                                | changing faster than the rate-of change alarm setting in seconds for main input. |   |
| -rE1                         | Rate of change (minutes) | Input 1      |                                | changing faster than the rate-of change alarm setting in minutes for input 1.    |   |
| -rS1                         | Rate of change (seconds) | Input 1      |                                | changing faster than the rate-of change alarm setting in seconds for input 1.    |   |
| -rE2                         | Rate of change (minutes) | Input 2      |                                | changing faster than the rate-of change alarm setting in minutes for input 2.    |   |
| -rS2                         | Rate of change (seconds) | Input 2      |                                | is changing faster than the rate-of change alarm setting in seconds for input 2. |   |
| -LSP                         | Setpoint Low             | Main PV      |                                | The setpoint is:-  | below the low alarm setting   |
| -HSP                         | Setpoint High            | Main PV      |                                |  | above the high alarm setting  |
| Sbr                          |                          |              |                                |  | <b>S</b> ensor <b>B</b> reak alarm (open circuit input 1 or derived PV) |



If the **process value flashes** but no other alarm message is displayed, this indicates that the input which is being used as the PV is out of range.



## 2.2.5 Diagnostic Alarms

In addition to the process alarms given in the previous column the following diagnostic alarms may also appear. These warn that a fault exists in either the indicator or the connected devices.

| Alarm | What it means  | What to do about it  |
|-------|--|--|
| EEEr  | <i>Electrically Erasable Memory Error:</i> The value of an operator or configuration parameter has been corrupted.       | This fault will automatically select configuration level. Check all configuration parameters before returning to operator level. Once in operator level, check all operator parameters before resuming normal operation. If the fault persists or occurs frequently, return the unit for repair. |
| LLLL  | <i>Out of range low reading</i>  | Check the value of the input   |
| HHHH  | <i>Out of range high reading</i>   | Check the value of the input   |
| Err1  | <i>Error 1: ROM self-test fail</i>   | Return the indicator for repair  |
| Err2  | <i>Error 2: RAM self-test fail</i>   | Return the indicator for repair  |
| Err3  | <i>Error 3: Watchdog fail</i>  | Return the indicator for repair  |
| Err4  | <i>Error 4: Keyboard failure.</i> Stuck button, or a button was pressed during power up.                                 | Switch the power off and then on without touching any of the indicator buttons. If the error continues return the unit for repair.   |
| Err5  | <i>Error 5: Input circuit failure</i>  | Return the unit for repair   |
| HwEr  | <i>Hardware error</i><br>Indication that a module is of the wrong type, missing faulty, or a new module has been fitted. | Check that the correct modules are fitted. Go to configuration mode and set up the required parameter(s). Refer to the Engineering Handbook, Part Number Ha027240 for further information.   |
| Pwr.F | <i>Power failure: The line voltage is too low</i>  | Check that the supply is within rated limits   |
| rmI.F | <i>Remote input fail</i>   | Connect an input device (eg. transducer, thermocouple, mA source) to input 2   |

## 2.2.6 To Acknowledge An Alarm

An alarm can be acknowledged in two ways:-

1. Press the ACK/RESET button. (If this does not work it may have been disabled when the indicator was configured).
2. Press  and  together.

The action, which now takes place, will depend on the type of latching, which has been configured

### Non Latched Alarms

If the indicator has been configured for non-latching alarms the following action occurs:-

**Alarm condition present when the alarm is acknowledged,** will be indicated by a single flash of the alarm message and the beacon will continuously illuminate. This state will continue for as long as the alarm condition remains. When the alarm condition disappears the indication will also disappear.

If a relay has been attached to the alarm output, it will operate when the alarm condition occurs and remain in the operated condition until the alarm is acknowledged **AND** it is no longer present.

If the alarm condition disappears before it is acknowledged the alarm indication disappears as soon as the condition disappears.

### Latched Alarms

The indicator may have been configured for Automatic or Manual reset. The action which occurs when the acknowledge button is pressed is described below:-

#### Automatic.

The alarm continues to be active until both the alarm condition is removed **AND** the alarm is acknowledged. The acknowledgement can occur **BEFORE** the alarm condition is removed.

#### Manual

The alarm continues to be active until both the alarm condition is removed **AND** the alarm is acknowledged. The acknowledgement can only occur **AFTER** the alarm condition is removed.

## 2.2.7 Alarm Inhibit











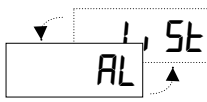

If a digital input has been configured for alarm inhibit, then all process alarm indication will be prevented for as long as the input is ON. When the input is turned to OFF any alarms which are active will be displayed. If a delay has been set on the alarm, the delay period will start from the time when the input is turned OFF. If the alarm has been configured as latching the latching action is also inhibited whenever the input is ON.

## 2.2.8 To Change The Alarm Setpoints (trip levels)

Parameters are grouped in 'lists' according to their function. Each list has a heading.

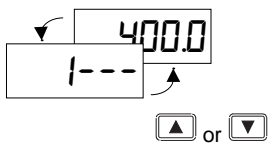
The  button steps through the parameter list headings (see section 2.4.1.)

The first list is the alarm setpoints list *AL*











| Do This   | This Is The Display You Should See  | Additional Notes  |
|---|---|---|
| 1. From any display press  as many times as necessary to show the 'Alarm List' header  |  |  If  or  are pressed the word 'L, St' is displayed for 2 secs<br> |
| 2. Press  to show the first parameter in the list<br>3. Press  or  to change the alarm setpoint  |  |  There are four alarm setpoints. The first character is the alarm number, the next three the alarm type (see section 2.2.4.)<br><br>If an alarm has been disabled in configuration level, it will not appear in this list.   |
| 4. To return to the HOME display:- <ul style="list-style-type: none"> <li>• Press  and  together</li> <li>• or continue to press </li> <li>• or the indicator will return to the HOME display if no button is pressed for 45 seconds (10 seconds if an alarm condition is present).</li> </ul> |   |   |

## 2.3 AUTO-TARE (DISPLAY ZERO)

The auto-tare function is used, for example, when it is required to weigh the contents of a container but not the container itself. Alternatively, it can be used to set a fixed offset on an initial measured value.

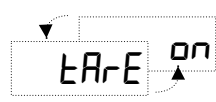
### 2.3.1 To Use Auto Tare

Place the empty container on the weigh-bridge. Then:-

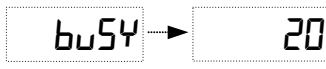
| Do This  | This Is The Display You Should See  | Additional Notes  |
|--|---|---|
| 1. From any display press  as many times as necessary to show the 'CAL 1 List' header   |  |  Use <i>CAL2</i> if the load cell is connected to input 2  |
| 2. Press  to scroll to <i>tArE</i><br>3. Press  or  and change from <i>OFF</i> to <i>on</i> |  |  The indicator automatically calibrates itself to the empty container.<br><br>When <i>tArE</i> is turned to <i>on</i> , the display will change to <i>buSY</i> . When calibration is complete the display will return to the HOME display.<br><br>It will then return to the main display.<br><br>If the calibration fails the alarm message <i>tdrF</i> (transducer fail) will flash. Press  and  to acknowledge.<br><br> |
| 4. Return to the HOME display as described above   |   |   |

Note:-  
The indicator will not return to the HOME display until the calibration procedure completes.  
If calibration does not complete after a period of 5 minutes, then calibration is aborted.

The full list of parameters available in these lists is shown in the parameter tables is shown in the following section.

## 2.4 TO ACCESS AND CHANGE PARAMETER VALUES

Parameters are settings within the indicator, which determine how it will operate. Examples are Alarm Setpoints and Tare Values already mentioned. They are organised into different lists. Each list has a named heading which describes a particular subject, for example 'Alarms' (AL).

### 2.4.1 Operator Level Navigation Diagram (factory default)

To find a parameter:-

Press to select the list heading

Press to select the parameter

Press or to change its value

Examples are shown in sections 2.2.8. and 2.3.1.

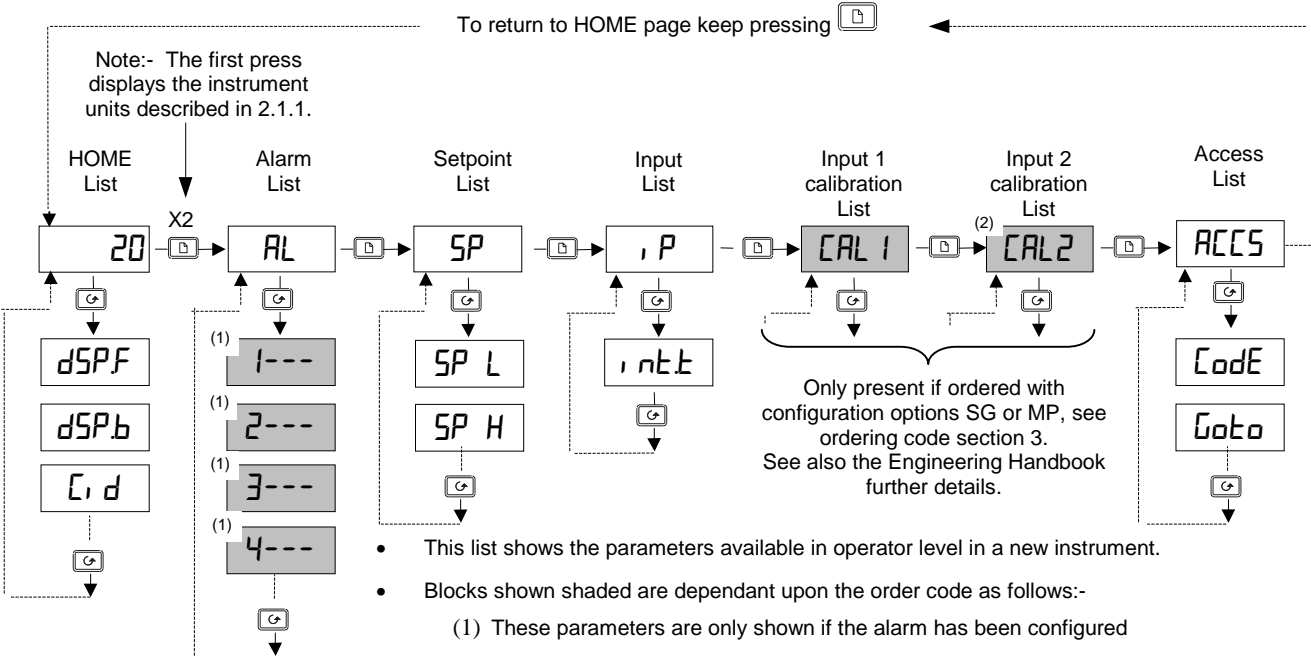

- This list shows the parameters available in operator level in a new instrument.
- Blocks shown shaded are dependant upon the order code as follows:-
  - (1) These parameters are only shown if the alarm has been configured
  - (2) CAL2 list is only shown if Input 2 has been configured
- The above list can be customised to suit the requirements of a particular process. Complete lists or individual parameters in a list can be added during commissioning. The procedure is described in section 3.4 'To Hide, Reveal and Promote Parameters'.

## 2.5 PARAMETER TABLES

The parameter tables provide a full list of parameters, an explanation of their use and where to find them.

Use these lists to adjust:-

- The alarm setpoints
- The alarm setpoint limits
- The User calibration
- The input filter time constant
- The communications address

20

### 2.5.1 HOME List



| HOME  | Home List  | Selectable options  | Default  |    |
|-------|--|---|--|----|
| dSPF  | HOME display front   | <nonE><br><SP><br><rmSP><br><PUHi><br><PULo><br><PU><br><AL.SP> | The HOME display will be blank and only alarm messages will be flashed<br>Setpoint (for deviation alarms)<br>Remote setpoint (for deviation alarms)<br>Displays the maximum value on input 1. This parameter is the same as <LOGH> in <nFa> list<br>Displays the minimum value on input 1. This parameter is the same as <LOGL> in <nFa> list<br>Process Value<br>Alarm 1 setpoint | PU |
| dSP.b | HOME display back  | <L1><br><L2>  | Linearised input 1<br>Linearised input 2   |    |
| C,d   | Customer defined identity number associated with a physical position | 0 to 9999   |  | 0  |

| 2.5.2 Alarm List  |                  |  |   |         |
|---|------------------|--|---|---------|
|  |                  |  |   |         |
| AL  | Alarm list       | Comments   | Adjustable Range                              | Default |
| 1---  | Alarm 1 setpoint | The last three letters indicate the Alarm type. See section 2.2.4. If the alarm is disabled the parameter will not appear in this list | Between low and high setpoint limits which    | 0       |
| 2---  | Alarm 2 setpoint |  | As set in the SP list.                        | 0       |
| 3---  | Alarm 3 setpoint |  | Rate of change alarms are direction sensitive | 0       |
| 4---  | Alarm 4 setpoint |  | from -9999 to +99999 units/sec or min         | 0       |

| 2.5.3 Setpoint List   |                                 |  |                   |
|---|---------------------------------|--|-------------------|
|  |                                 |  |                   |
| SP  | Setpoint list                   | Adjustable Range                                     | Default           |
| SP L  | Setpoint low limit – PV alarms  | Input range min and max (combination of inputs 1 & 2 | As per order code |
| SP H  | Setpoint high limit – PV alarms |  |                   |

| 2.5.4 Input List  |  |                      |         |
|---|--|----------------------|---------|
|  |  |                      |         |
| , P   | Setpoint list  | Adjustable Range     | Default |
| , n t t   | Input filter <u>int</u> egrating <u>ti</u> me constant<br>Set to a value which reduces the effect of any input noise to an acceptable level. The higher the value the more sluggish the response | OFF to 999.9 seconds | 1.6     |

| 2.5.5 User Calibration Lists – Inputs 1 and 2                                       |   |   |         |
|---|---|---|---------|
| CAL. 1 or CAL. 2 (CAL. 2 only appears if input 2 has been configured)               |   |   |         |
|  |   |   |         |
| CAL.-   | User calibration 1 or 2 list                                  | Adjustable Range  | Default |
| tArE  | Performs automatic 'Tare' correction<br>See also section 2.3. | OFF = Off<br>on = start correction<br>bu54 = inputting value<br>donE = finished inputting value | OFF     |

| 2.5.6 Access List   |   |
|---|---|
|  |   |
| ACCS  | The Access List provides password protected access to further levels of operation as listed below. See section 3 of the Engineering Handbook, part No. HA027240, for further details.   |
| code  | A code number can be entered using the  or  buttons. If an incorrect code number is entered the display will revert to <code>. If no button is pressed within 45 seconds the indicator will automatically return to the HOME display. |

For information on further levels of access, see the following sections.



Details of configuration are not included in this operation guide. A full engineering reference and configuration manual is available from the Eurotherm web site or as a booklet, part number HA027240.

# 3 Ordering Code

| Model number | Function | Display colour | Supply voltage | Module 1 | Module 2 | Module 3 | Relay Output 1 | Comms Module | PDS Module | Manual |
|--------------|----------|----------------|----------------|----------|----------|----------|----------------|--------------|------------|--------|
| 2408i        | AL       |                |                |          |          |          |                |              |            |        |

| Function |                      |
|----------|----------------------|
| AL       | Indicator/Alarm unit |
| AP       | Profibus Indicator   |

| Display colour |               |
|----------------|---------------|
| GN             | Green display |
| RD             | Red display   |

| Supply voltage |             |
|----------------|-------------|
| VH             | 85-264Vac   |
| VL             | 20-29Vac/dc |

| Modules 1, 2 and 3  |  |
|---|--|
| XX  | Module not fitted                        |
| <b>Alarm Relay output (change-over)</b>                                 |  |
| R4  | Module fitted unconfigured               |
| OR  | Select alarm configuration from table A. |
| <b>DC retransmission</b>  |  |
| D6  | Module fitted unconfigured               |
| First character   |  |
| V-  | Process Value retransmission             |
| S-  | Setpoint retransmission                  |
| Z-  | Error retransmission                     |
| Second character  |  |
| -1  | 0-20mA                                   |
| -2  | 4-20mA                                   |
| -3  | 0-5Vdc                                   |
| -4  | 1-5Vdc                                   |
| -5  | 0-10Vdc                                  |
| <b>Dual relay (Note 2)</b>  |  |
| RR  | Module fitted unconfigured               |
| <b>Triple contact input (Note 3)</b>                                    |  |
| TK  | Module fitted unconfigured               |
| <b>Triple logic input (Note 3)</b>                                      |  |
| TL  | Module fitted unconfigured               |
| <b>Triple logic output (Note 4)</b>                                     |  |
| TP  | Module fitted unconfigured               |
| <b>20mA Transmitter supply</b>  |  |
| MS  | 24Vdc, 20mA supply                       |
| <b>Strain Gauge Transducer supply (modules 1 &amp; 2 only) (note 5)</b> |  |
| G3  | 5V transducer supply                     |
| G5  | 10v transducer supply                    |
| <b>2nd analogue input (module 3 only)</b>                               |  |
| D5  | Module fitted unconfigured               |
| For configuration, see PV Function field                                |  |

| Relay Output 1 |   |
|----------------|---|
| XX             | Not fitted                              |
| RF             | Fitted unconfigured                     |
| OR             | Select alarm configuration from table A |

**Table A:**  
**Alarm relay configuration**  
 (See note 1)  
**Non-latched alarms**

|    |                       |
|----|-----------------------|
| FH | High alarm            |
| FL | Low alarm             |
| DB | Deviation band alarm  |
| DL | Deviation low alarm   |
| DH | Deviation high alarm  |
| RA | Rate-of -change alarm |

**Latched alarms**

|    |                       |
|----|-----------------------|
| HA | High alarm            |
| LA | Low alarm             |
| BD | Deviation band alarm  |
| WD | Deviation low alarm   |
| AD | Deviation high alarm  |
| RT | Rate-of -change alarm |
| NW | New alarm             |

| Comms module                           |                            |
|--|----------------------------|
| XX                                     | Module not fitted          |
| <b>RS232 Module</b>                    |                            |
| A2                                     | Module fitted unconfigured |
| AM                                     | Modbus protocol            |
| AE                                     | EI-Bisynch protocol        |
| <b>RS485 (2-wire) Module</b>           |                            |
| Y2                                     | Module fitted unconfigured |
| YM                                     | Modbus protocol            |
| YE                                     | EI-Bisynch protocol        |
| <b>RS485 (4-wire) (= RS422) Module</b> |                            |
| F2                                     | Module fitted unconfigured |
| FM                                     | Modbus protocol            |
| FE                                     | EI-Bisynch protocol        |
| <b>Profibus Module</b>                 |                            |
| PB                                     | High speed RS485           |

| PDS module |                            |
|------------|----------------------------|
| XX         | Module not fitted          |
| M6         | Module fitted unconfigured |
| RS         | Remote setpoint input      |

| Manual |         |
|--------|---------|
| XXX    | None    |
| ENG    | English |
| FRA    | French  |
| GER    | German  |
| NED    | Dutch   |
| SPA    | Spanish |
| SWE    | Swedish |
| ITA    | Italian |

Note 1: By default, alarm 1 will be assigned to relay output 1 and alarms 2, 3 and 4 will be assigned to Modules 1, 2 and 3 respectively.

Note 2: The allocation of alarms to the dual relay outputs must be performed in configuration by the customer.

Note 3: Triple contact or logic inputs can be configured, by the user, for any of the functions listed under Digital Inputs 1 and 2.

Note 4: The triple logic output can be configured as alarm outputs or as telemetry outputs via digital communications.

Note 5: By default, the transducer supply for input 1 will be installed in module position 2 and the transducer supply for input 2 in module position 1.

| SOFTWARE CONFIGURATION |              |              |               |                 | Configuration of 2 <sup>nd</sup> analogue input requires D5 in module 3 |                          |             |                                   |                                   |                      |
|------------------------|--------------|--------------|---------------|-----------------|---|--------------------------|-------------|-----------------------------------|-----------------------------------|----------------------|
| Sensor Input           | Setpoint min | Setpoint max | Display Units | Digital input 1 | Digital input 2   | 2 <sup>nd</sup> DC Input | PV Function | 2 <sup>nd</sup> Input Display Min | 2 <sup>nd</sup> Input Display Max | Configuration option |
|                        | Note 6       | Note 6       |               |                 |   | Note 7                   |             | Note 8                            | Note 8                            |                      |

| Sensor input & 2nd DC input                               |   | Setpoint min & max       |             |              |      |
|---|---|--------------------------|-------------|--------------|------|
|   |   | °C                       |             | °F           |      |
|   |   | Min                      | Max         | Min          | Max  |
| <b>Thermocouples</b>                                      |   |                          |             |              |      |
| J   | Type J  | -210                     | 1200        | -340         | 2192 |
| K   | Type K  | -200                     | 1372        | -325         | 2500 |
| T   | Type T  | -200                     | 400         | -325         | 750  |
| L   | Type L  | -200                     | 900         | -325         | 1650 |
| N   | Type N  | -250                     | 1300        | -418         | 2370 |
| R   | Type R  | -50                      | 1768        | -58          | 3200 |
| S   | Type S  | -50                      | 1768        | -58          | 3200 |
| B   | Type B  | 0                        | 1820        | 32           | 3308 |
| P   | Platinell II                                    | 0                        | 1369        | 32           | 2496 |
| Z   | Pt100   | -200                     | 850         | -325         | 1562 |
| <b>Process inputs (Scaled to setpoints max &amp; min)</b> |   |                          |             |              |      |
|   |   | Range Min                |             | Range Max    |      |
| F   | -100 to +100mV                                  | -9999                    |             | 99999        |      |
| Y   | 0 to 20mA (note 2)                              | -9999                    |             | 99999        |      |
| A   | 4 to 20mA (note 2)                              | -9999                    |             | 99999        |      |
| W   | 0 to 5Vdc                                       | -9999                    |             | 99999        |      |
| G   | 1 to 5Vdc                                       | -9999                    |             | 99999        |      |
| V   | 0 to 10Vdc                                      | -9999                    |             | 99999        |      |
| <b>Factory downloaded input</b>                           |   |                          |             |              |      |
| C   | Type C -W5%Re/W26%Re (default downloaded input) | "Table Reference Number" | 0 to 2319   | 32 to 4200   |      |
| D   | Type D - W3%Re/W25%Re                           | "T035"                   | 0 to 2399   | 32 to 4350   |      |
| E   | E thermocouple                                  | "T012"                   | -270 to 999 | -450 to 1830 |      |
| 1   | Ni/Ni18%Mo                                      | "T033"                   | 0 to 1399   | 32 to 2550   |      |
| 2   | Pt20%Rh/Pt40%Rh                                 | "T025"                   | 0 to 1870   | 32 to 3398   |      |
| 3   | W/W26%Re (Engelhard)                            | "T09"                    | 0 to 2000   | 32 to 3632   |      |
| 4   | W/W26%Re (Hoskins)                              | "T029"                   | 0 to 2010   | 32 to 3650   |      |
| 5   | W5%Re/W26%Re (Engelhard)                        | "T011"                   | 10 to 2300  | 50 to 4172   |      |
| 6   | W5%Re/W26%Re (Bucose)                           | "T038"                   | 0 to 2000   | 32 to 3632   |      |
| 7   | Pt10%Rh/Pt40%Rh                                 | "T023"                   | 200 to 1800 | 392 to 3272  |      |
| 8   | Exergen K80 I.R. Pyrometer                      | "E <sub>BB</sub> "       | -45 to 650  | -49 to 1202  |      |

| Display Units |    |   |       |
|---------------|----|---|-------|
| C             | °C | K | °K    |
| F             | °F | X | Blank |

| PV function |                                 |
|-------------|---------------------------------|
| XX          | Input 1 displayed               |
| LO          | PV = the lowest of i/p 1 and 2  |
| HI          | PV = the highest of i/p 1 and 2 |
| FN          | PV derived from i/p 1 and 2     |
| RS          | Remote setpoint                 |

| Digital inputs 1 & 2 |  |
|----------------------|--|
| XX                   | Disabled   |
| AC                   | Alarm acknowledge  |
| KL                   | Keylock  |
| SR                   | Remote setpoint select   |
| PV                   | Select process value input 2   |
| M5                   | CTX mode 5 (digital input 2 only). For use with PDTCX 'smart' current transformer. |
| J1                   | Initiate tare correction on strain gauge input 1                                   |
| J2                   | Initiate tare correction on strain gauge input 2                                   |
| J3                   | Initiate automatic calibration of strain gauge input 1                             |
| J4                   | Initiate automatic calibration of strain gauge input 2                             |

| Configuration Option |                        |
|----------------------|------------------------|
| XX                   | Standard               |
| SG                   | Load cell/strain gauge |
| CL                   | pressure transducer    |

Note 6: Setpoint min and max: Include the decimal points required in the displayed value; up to one for temperature, up to two for process inputs.

Note 7: Select the code required from the Sensor Input table

Note 8: These two fields are used to scale the 2<sup>nd</sup> DC input if it is a linear process input, otherwise it should be left blank.

Note 9: For mA inputs, a 1% 2.49Ω current sense resistor is supplied. If greater accuracy is required, a 0.1% resistor can be ordered as Part number SUB2K/249R.1

## 4 Safety and EMC Information

### Safety

This indicator complies with the European Low Voltage Directive 73/23/EEC, amended by 93/68/EEC, by the application of the safety standard EN 61010.

### Electromagnetic compatibility

This indicator conforms to the essential protection requirements of the EMC Directive 89/336/EEC, amended by 93/68/EEC, by the application of a Technical Construction File. This indicator satisfies the general requirements of the industrial environment defined in EN 50081-2 and EN 50082-2.

### General

The information contained in these instructions is subject to change without notice. While every effort has been made to ensure the accuracy of the information, your supplier shall not be held liable for errors contained herein.

### Unpacking and storage

The packaging should contain the indicator, two panel retaining clips, a 2.49Ω current sense resistor and this instruction leaflet.

If the packaging or the indicator is damaged, do not install the product but contact your supplier.

This indicator has no user serviceable parts. Contact your supplier for repair.

### Caution: Charged capacitors



Before removing the indicator from its sleeve, switch off the supply and wait two minutes to allow capacitors to discharge. Failure to observe this precaution may damage the indicator or cause mild electric shock.

### Precautions Against Electrostatic Discharge Damage



When the indicator is removed from its sleeve, it is vulnerable to damage by electrostatic. To avoid this, observe anti-static handling precautions.

### Cleaning

Do not use water or water based products to clean labels or they will become illegible. Isopropyl alcohol may be used to clean labels. A mild soap solution may be used to clean other exterior surfaces of the product.

### Safety Symbols

The following safety symbols are used on the controller and in this manual:

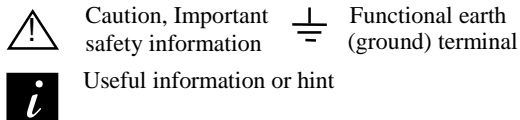

### Personnel

Installation must be carried out by qualified personnel.

### Enclosure of live parts

The indicator must be installed in an enclosure to prevent hands or metal tools touching parts that may be electrically live.

### Caution: Live sensors



The alarm acknowledge/keylock input is electrically connected to the sensor input (e.g. thermocouple). In some installations the temperature sensor may become live. The indicator is designed to operate under these conditions, but you must ensure that this will not damage other equipment connected to the logic input/output and that service personnel do not touch this connection while it is live. With a live sensor, all cables, connectors and switches for connecting the sensor and non-isolated inputs and outputs must be mains rated.

### Wiring



Wire the indicator in accordance with the wiring data given in these instructions. Take particular care not to connect AC supplies to the low voltage sensor input or logic outputs. Only use copper conductors for connections, (except thermocouple). Ensure that the installation complies with local wiring regulations, and observe maximum voltage safety limits.

### Power Isolation



The installation must include a power isolating switch or circuit breaker that disconnects all current carrying conductors. The device should be mounted in close proximity to the indicator, within easy reach of the operator and marked as the disconnecting device for the indicator.

### Voltage rating



The maximum continuous voltage applied between any connection and ground must not exceed 264Vac.

For the above reason the indicator should not be wired to a three-phase supply with an unearthed star connection. Under fault conditions such a supply could rise above 264Vac with respect to ground and the product would not be safe.

### Conductive pollution



Electrically conductive pollution must be excluded from the cabinet in which the indicator is mounted. For example, carbon dust is a form of electrically conductive pollution. Where condensation is likely, for example at low temperatures, include a thermostatically controlled heater in the cabinet.

### Installation requirements for EMC

- For general guidance refer to EMC Installation Guide, HA025464.
- It may be necessary to fit a filter across the relay output to suppress conducted emissions. The filter requirements will depend on the type of load. For typical applications we recommend Schaffner FN321 or FN612.

### Routing of wires

To minimise the pick-up of electrical noise, the sensor input wiring should be routed away from high-current power cables. Where it is impractical to do this, use shielded cables with the shield grounded at both ends.

## 5 Technical Specification

### Main process value input and second DC input

|  |   |
|--|---|
| Low level range                          | -100 to +100mV  |
| High level range                         | 0-20mA or 0-10Vdc   |
| Sample rate                              | 9Hz   |
| Resolution                               | <2 $\mu$ V for low level inputs<br><2mV for high level inputs                         |
| Linearity                                | Better than 0.2°C   |
| Calibration accuracy                     | $\pm$ 0.2% of reading, or $\pm$ 1°C or $\pm$ 1LSD, whichever is the greater           |
| User calibration                         | Low and high offsets can be applied   |
| Input filtering                          | OFF to 999.9 seconds  |
| Thermocouple types                       | Refer to ordering code sensor input table   |
| Cold junction compensation               | In automatic mode, >30:1 rejection of ambient temperature change.                     |
| 3-wire Pt100 input. Bulb current:        | 0.3mA   |
| Maximum lead resistance                  | Up to 22 $\Omega$ in each lead without error  |
| 2 <sup>nd</sup> analogue input functions | 2 <sup>nd</sup> process value, remote setpoint, select min, select max, derived value |
| Input impedance, mV inputs               | >10M $\Omega$   |
| Input impedance, Volt inputs             | >69K $\Omega$   |

### Digital inputs

### Contact closure or open collector inputs

Note: These are powered by the controller

|  |   |
|--|---|
| Digital inputs 1 & 2<br>(Non isolated from PV) | Switching voltage/current:<br>24Vdc/20mA nominal<br>Off state resistance <100 $\Omega$<br>On state resistance >28K $\Omega$ |
| Triple contact closure inputs                  | Isolated. Specification as dig. inputs 1 & 2  |

### Externally powered inputs

|                     |   |
|---------------------|---|
| Triple logic inputs | Off state: <5Vdc<br>On state: 10.8 to 30Vdc @ 2.5mA |
|---------------------|---|

### Digital input functions

As per digital inputs 1 & 2 in the ordering code

### Digital outputs

|                          |                          |
|--------------------------|--------------------------|
| Relay rating             | 2A, 264Vac resistive     |
| Triple logic output      | 8mA, 12Vdc per channel   |
| Digital output functions | as per the ordering code |

## 6 International Sales & Service

### EUROTHERM CONTROLS LTD

Faraday Close, Durrington, Worthing, West Sussex BN13 3PL

Telephone Sales: (01903) 695888  
Technical: (01903) 695777  
Service: (01903) 695444  
Fax (01903) 695666

Countries not listed - enquiries/orders to:  
Eurotherm Controls Limited,  
Export Dept., Faraday Close, Durrington,  
Worthing, West Sussex, BN13 3PL  
Telephone (01903) 268500  
Fax (01903) 265982

#### AUSTRALIA

Eurotherm Pty. Ltd.  
Telephone Sydney (+61 2) 9477 7022  
Fax (+61 2) 477 7756

#### AUSTRIA

Eurotherm GmbH  
Telephone Vienna (+43 1) 798 7601  
Fax (+43 1) 798 7605  
Telex 047 1132000 EIAUT A

#### BELGIUM

Eurotherm B.V.  
Telephone Antwerp (+32 3) 322 3870  
Fax (+32 3) 321 7363

#### DENMARK

Eurotherm A/S

Telephone Copenhagen (+45 31) 871622  
Fax (+45 31) 872124

#### FRANCE

Eurotherm Automation SA  
Telephone Lyon (+33 478) 664500  
Fax (+33 478) 352490

#### GERMANY

Eurotherm Regler GmbH  
Telephone Limburg (+49 6431) 2980  
Fax (+49 6431) 298119  
Also regional offices

#### HONG KONG

Eurotherm Limited  
Telephone Hong Kong (+852) 2873 3826  
Fax (+852) 2870 0148  
Telex 0802 69257 EIFEL HX

#### INDIA

Eurotherm India Limited  
Telephone Chennai (+9144) 4961129  
Fax (+9144) 4961831

#### IRELAND

Eurotherm Ireland Limited  
Telephone Naas (+353 45) 879937  
Fax (+353 45) 875123

#### ITALY

Eurotherm SpA  
Telephone Como (+39 31) 975111  
Fax (+39 31) 977512  
Telex 380893 EUROTH I

#### JAPAN

Eurotherm Japan Limited  
Telephone Tokyo (+81 3) 33702951  
Fax (+81 3) 33702960

#### KOREA

Eurotherm Korea Limited  
Telephone Seoul (+82 2) 5438507  
Fax (+82 2) 545 9758  
Telex EIKOR K23105

#### NETHERLANDS

Eurotherm B.V.  
Telephone Alphen a/d Ryn  
(+31 172) 411752  
Fax (+31 172) 417260

#### NEW ZEALAND

Eurotherm Limited  
Telephone Auckland (+64 9) 2635900  
Fax: (+64 9) 2635901

### DC retransmission

|                       |                                       |
|-----------------------|---------------------------------------|
| Range                 | Scaleable between 0-20mA and 0-10Vdc  |
| Resolution            | 1 part in 10,000                      |
| Retransmission values | Process value, setpoint or error from |

### Transmitter supply

|        |             |
|--------|-------------|
| Rating | 20mA, 24Vdc |
|--------|-------------|

### Strain gauge bridge supply

|                         |  |
|-------------------------|--|
| Bridge voltage          | Software selectable, 5 or 10Vdc                                      |
| Bridge resistance       | 300 $\Omega$ to 10K $\Omega$   |
| Internal shunt resistor | 30.1K $\Omega$ at 0.25%, used for calibration of 350 $\Omega$ bridge |

### Alarms

|                  |  |
|------------------|--|
| Number of alarms | Four   |
| Alarm types      | High, low, deviation high, deviation low, deviation band, rate of change in units/sec, rate of change in units/min, new alarm status. Sensor break alarm |
| Alarm modes      | Latching or non-latching. Blocking Energised or de-energised in alarm  |
| Alarm delay      | OFF to 999.9 secs  |

### Communications

|              |                                      |
|--------------|--------------------------------------|
| Module types | RS232, 2-wire RS485 and 4-wire RS485 |
| Protocols    | Modbus® or EI-Bisynch (ASCII)        |

### PDS

|           |  |
|-----------|--|
| Functions | Remote setpoint input from master controller |
|-----------|--|

### General

|                     |   |
|---------------------|---|
| Display colour      | Red or green options  |
| Number of digits    | Five with up to three decimal places                                      |
| Supply              | 100 to 240Vac -15%+10% OR 24 Vdc or ac -15%+20%                           |
| Power consumption   | 15W max   |
| Operating ambient   | 0 to 55°C and 5 to 95% RH non-condensing                                  |
| Storage temperature | -10 to +70°C  |
| Panel sealing       | IP65  |
| Dimensions          | 96W x 48H x 150D  |
| Weight              | 400g max  |
| EMC Standards:      | EN50081-2 & EN50082-2 generic standards for industrial environments       |
| Safety standards    | Meets EN 61010, Installation category II, pollution degree 2.             |
| Atmospheres         | Not suitable for use above 2000m or in explosive or corrosive atmospheres |

#### NORWAY

Eurotherm A/S  
Telephone Oslo (+47 66) 803330  
Fax (+47 66) 803331

#### SPAIN Eurotherm España SA

Telephone (+34 91) 6616001  
Fax (+34 91) 6619093

#### SWEDEN

Eurotherm AB  
Telephone Malmö (+46 40) 384500  
Fax (+46 40) 384545

#### SWITZERLAND

Eurotherm Produkte (Schweiz) AG  
Telephone Zurich (+41 55) 4154400  
Fax (+41 55) 4154415

#### U.S.A

Eurotherm Controls Inc.  
Telephone Reston (+1 703) 787 3405  
Fax (+1 703) 787 3436